

# COUNTDOWN CHECKLIST

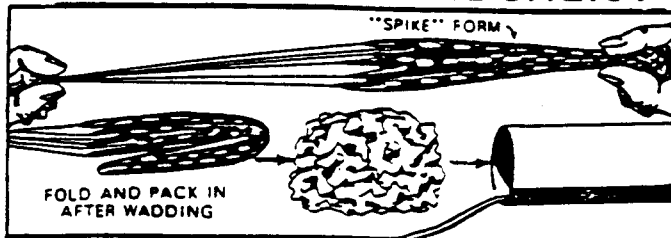

-16- Pack flameproof recovery wadding into the upper stage body tube from the top. The wadding should be located 5 or 6 inches down the tube and should fill the tube for a length of 2 to 2-1/2 inches, sealing tightly against the sides of the tube. Hold the parachute between two fingers at its center and pass the other hand down it to form a "spike" shape as illustrated. Fold this spike in two or three sections and push the folded parachute down into the tube on top of the wadding. Pack the shroud lines and shock cord in on top of the parachute and slide the payload section into place.

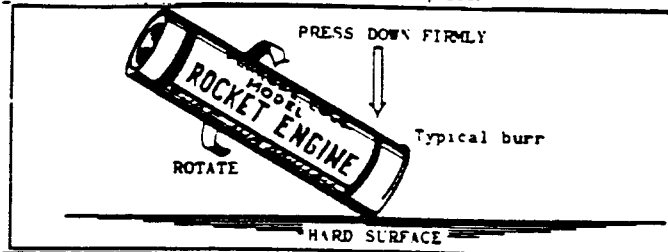

-15- Select an upper stage engine and a booster engine. Remove any burrs from the ends of the engines by holding them against a smooth surface and turning as in fig. 18.

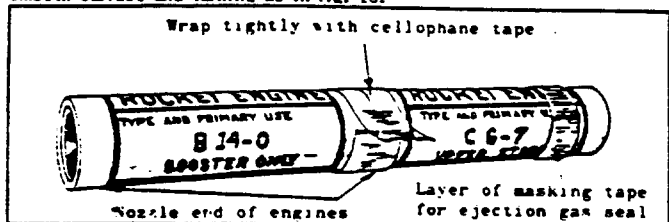

-14- Position the engines with the nozzle of the upper stage engine against the top end of the booster engine and wrap a layer of cellophane tape tightly around the joint as shown in fig. 19. Check to be sure the engines are in their proper relative positions.

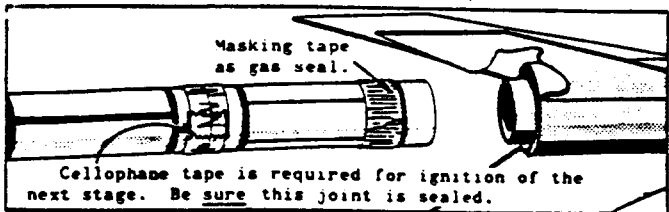

-13- Wrap masking tape around the top of the upper stage engine so it makes a tight friction fit in the engine mount tube. Insert the upper stage end of the engine unit into the upper stage engine mount and finish securing it by wrapping a layer of masking tape around the end of the engine mount tube and the end of the engine as shown in fig. 20. Press the tape tight against the engine.

-12- Slide the booster into place on the engine unit from the bottom, positioning it so the stage coupler fits all the way into the upper stage and so the fins are in line. Secure the booster in place by wrapping a layer of masking tape around the end of the engine mount tube and the engine and pressing the tape down tightly.

-11- Form an electrical igniter and insert it in the booster engine nozzle as directed in the instructions which came with the engine.

-10- Load the payload into the payload section. Secure the nose cone by wrapping a layer of tape around the joint between cone and payload section tube.

-9- Place the rocket on the launcher. Check to be sure the panel is disarmed. Clean the micro-clips and attach them to the igniter.

-8- Clear the launch area, alert the recovery crew and trackers.

-7- Check for low flying aircraft and unauthorized persons in the recovery area.

-6- Arm the launch panel.

-5 -4 -3 -2 -1 LAUNCH!

Length 32.25 in.

Dia. 1.325 in.

Weight 2.7oz.

## Astron

# AVENGER

## 2 Stage Payload Rocket

## Parachute Recovery

## ASTRON AVENGER

KIT No.  
**K-38**

Recommended Engines  
Booster A8-0 F6-0 B14-0 C6-0  
Upper Stage A5-4 F6-6 C6-7

Also Can Use

B3-6 B4-4 B4-2

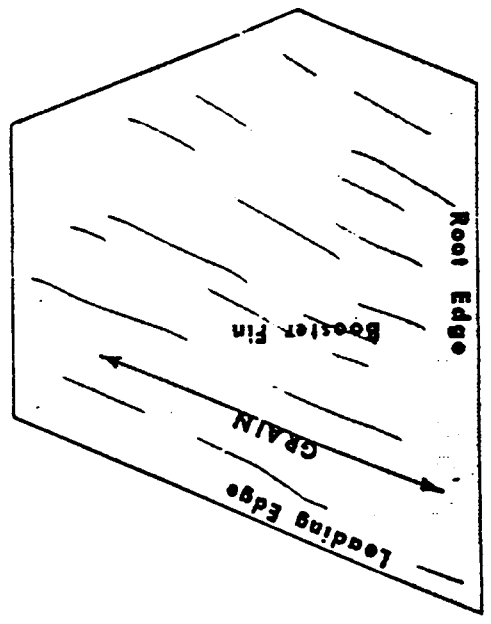
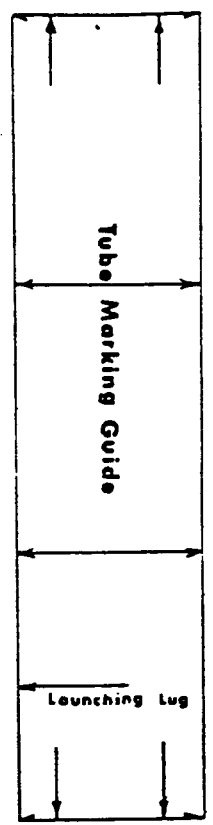
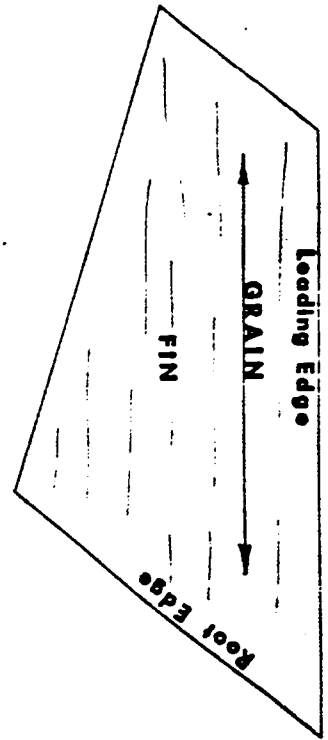

SP-38

# ASTRON AVENGER

Your Astron Avenger two-stage model rocket kit consists of the following parts as illustrated in the drawing at right:

- A) 1 Payload Section Tube—Part #BT-50H
- B) 1 Upper Stage Body Tube—Part #BT-55V
- C) 1 Booster Body Tube—Part #BT-55J
- D) 1 Engine Mount Tube—Part #BT-20J
- E) 1 Engine Mount Tube—Part #BT-20M
- F) 3 Tube Couplers—Part #JT-55C
- G) 4 Adapter Rings—Part #RA-2055
- H) 1 Engine Block—Part #EB-20A
- I) 1 3/32" Thick Fin Stock—Part #BFS-30
- J) 1 1/8" Thick Fin Stock—Part #BFS-40
- K) 1 Balsa Adapter—Part #TA-5055
- L) 1 Nose Cone—Part #BNC-50Y
- M) 1 Shock Cord—Part #SC-3
- N) 1 Screw Eye—Part #SE-1
- O) 1 Parachute—Part #PK-18A
- P) 6 Tape Strips—Part #TD-2F
- Q) 108" Shroud Line Cord—Part #SLT-18
- R) 1 Launch Lug—Part #LL-2B
- S) 1 Launch Lug Stand-off—Part #WD-2B
- T) 1 Pattern Sheet—Part #SP-3R
- U) 1 Technical Report—Part #TR-2

In addition to the materials included in your kit you will also need the following tools and supplies:

- 1) Modeling knife or single edge razor blade
- 2) Scissors
- 3) Extra-strong white glue
- 4) Ball point pen or pencil
- 5) Fine and extra fine grit sandpaper
- 6) White paint or dope

Read the entire assembly instructions carefully before beginning work on your rocket. Then start construction, following each step in order, checking off each step as it is completed.

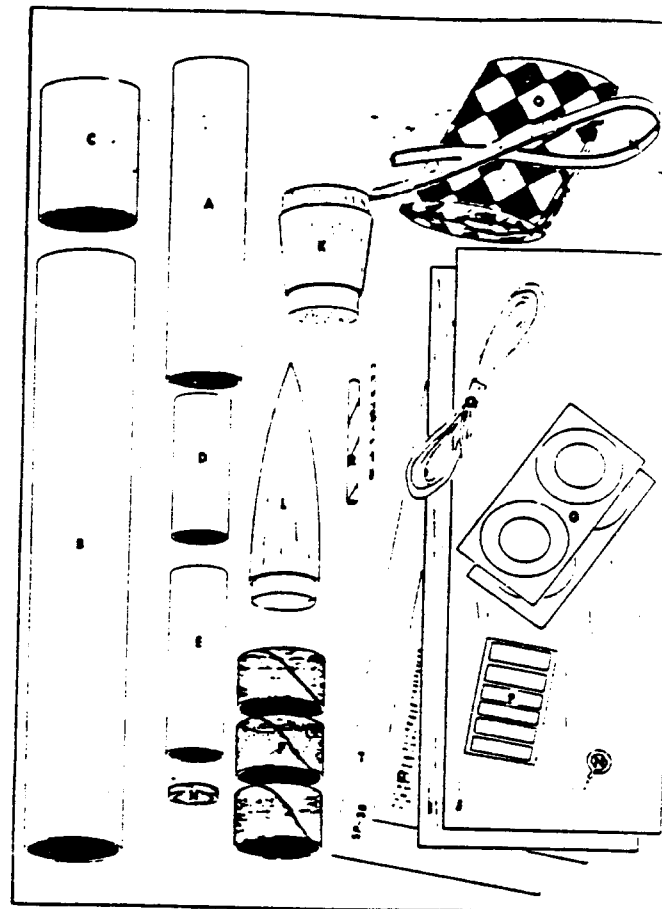

## Assembly Instructions

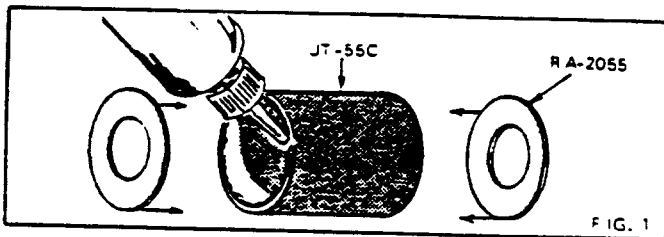

1. Glue one adapter ring to each end of two of the tube couplers. (Do not glue anything to the other coupler yet.) Apply glue to the very end of the tube coupler as in fig. 1, then press the ring in place so it is exactly centered. Wipe off any excess glue and set the two ring-coupler units aside to dry thoroughly.

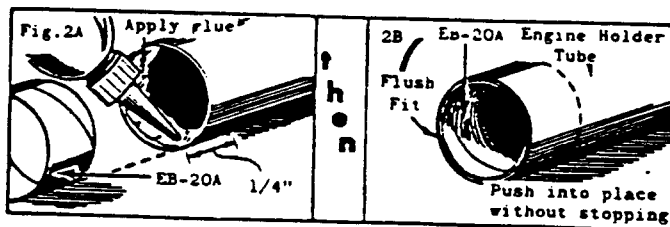

2. Glue the engine block in one end of the 2-3/4" long engine mount tube (be sure you use the correct tube). To do this, apply glue to the last 1/4" of the inside of the tube, then slide the engine block into the tube until the end of the block is even with the end of the tube (see fig. 2).

3. Cut out the fin patterns exactly on the edge lines. You will notice that one sheet of fin stock is thicker than the other. *The booster fins are cut from the thick sheet and the upper stage fins from the thin sheet.* Position the fin patterns on the balsa sheets as shown in fig. 3 with the grain of the balsa matching the grain direction shown on the pattern. Trace around the patterns with a ball point pen to mark three fins for each stage.

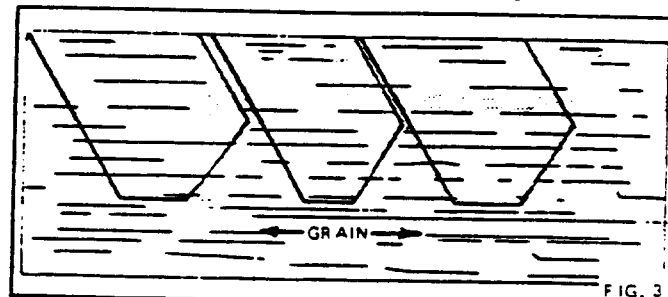

- Cut out the fins with a sharp modeling knife or single edge razor blade. Sand the sides of the fins until smooth. Sand until smooth around all edges *except* the root edge (the edge which will be attached to the body). Sand the root edge of each fin so it is square and flat.

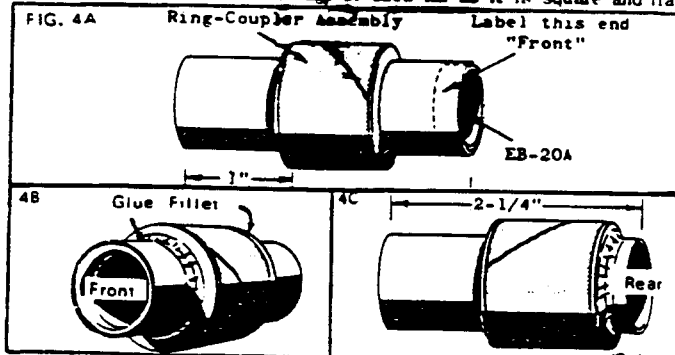

4. After the glue on the ring-coupler units has dried completely, mark the 2-3/4" long engine mount tube 1" from the end that does *not* have the engine block. Position one of the ring-coupler units on the engine mount tube as shown in fig. 4A. The rear ring should be exactly on the mark. Spread glue around both ring-tube joints as in fig. 4B. Make sure the entire joint is well covered, wipe off any excess glue with your finger and set the unit aside to dry completely. Next mark the 2-1/4" long engine mount tube 5/16" from one end and glue the remaining ring-coupler unit in place as shown in fig. 4C. Set this aside to dry completely.

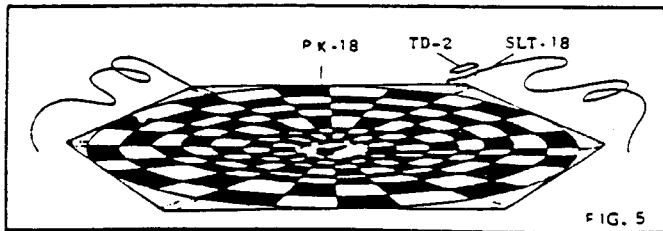

5. While waiting for the engine mount units to dry, assemble the parachute. Cut out the chute on its edge lines as indicated on the plastic. Cut six 18" lengths of shroud line cord and attach one shroud line to each point of the parachute with a tape strip as shown in fig. 5. Tie the free ends of the lines together.

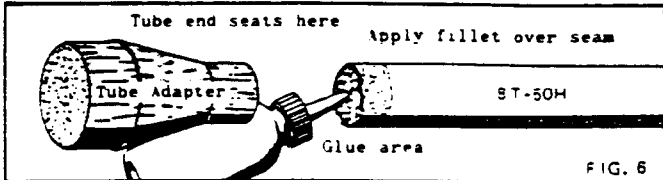

6. Apply a line of glue around the inside of one end of the BT-50H payload section tube. Insert the small end of the TA-5055 adapter into the tube and push the two pieces together until they match perfectly (fig. 6).

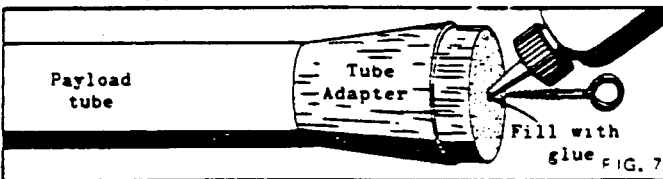

7. Insert the screw eye into the large end of the adapter. Remove the screw eye, press the nozzle of the glue bottle to the hole and squirt glue into the hole. Replace the screw eye and wipe away any excess glue.

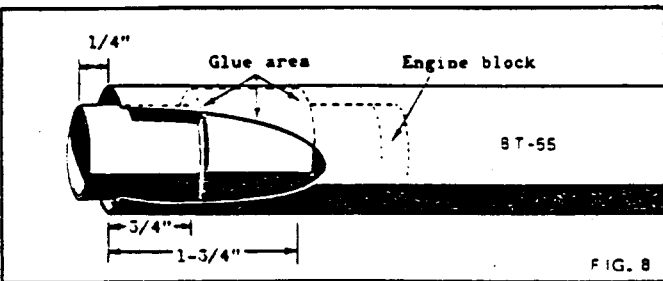

8. When the engine mount units have dried completely, check their fit in the BT-55 body tubes. Sand the edges of the rings until they make a smooth slide fit inside the body tubes. Mark the upper stage mount (the one with the longer tube) 1/4" from the end that does not have the engine block. Smear glue around the inside of the BT-55V upper stage body tube to cover an area extending from 3/4" from the end to 1-3/4" from the end. Insert the engine mount unit, engine block end first, until the mark on the engine mount tube is exactly even with the end of the body tube. The completed assembly must be positioned as shown in fig. 6. Do not pause during this operation or the glue may set with the mount in the wrong position.

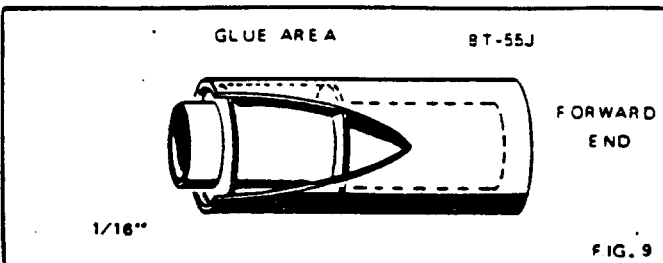

9. Smear glue around the inside of the BT-55J booster body tube to cover an area 1" deep at one end. Insert the engine mount unit, with the end that projects farthest first, into the booster body tube until the rear ring is 1/16" inside the tube as shown. Be especially careful to make this assembly exactly as the illustration shows. The rocket will not operate properly if any error is made in positioning.

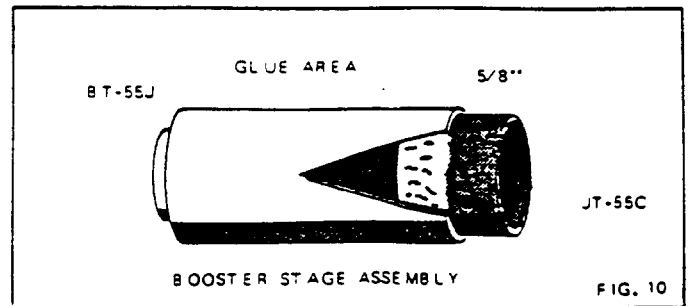

10. Apply glue to the inside of the forward end of the booster body tube to a depth of 5/8". Slide the remaining stage coupler into the end of the tube so that 5/8" of the coupler is inside the body and about 5/8" projects forward. Wipe away any excess glue.

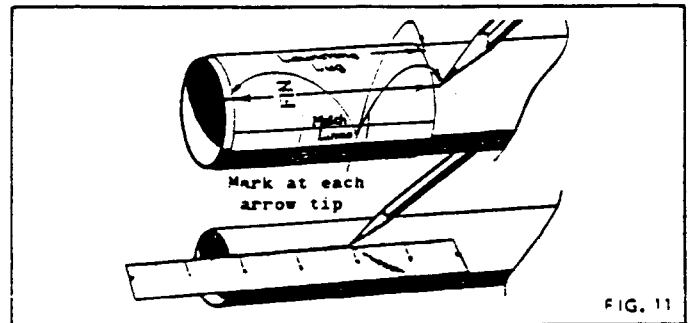

11. Cut out the fin spacing guide from the pattern sheet. Wrap it around the upper stage body at the end with the engine mount unit as shown. The alignment marks on the pattern should match perfectly. Mark the body at each of the arrow points, remove the guide and draw a straight line connecting the corresponding pairs of marks. Mark the booster body tube in the same way.

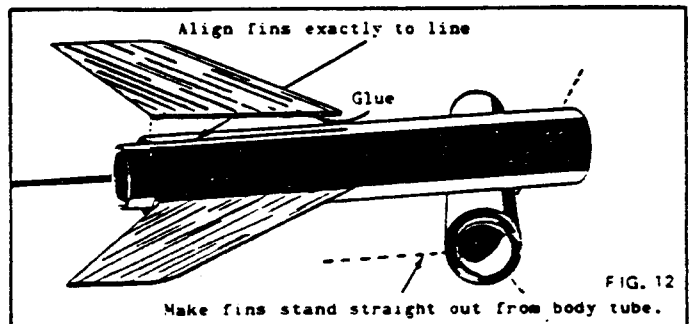

12. Apply glue to the root edge of one of the upper stage fins. Attach the fin to the upper stage body tube with the edge of the fin exactly on one of the lines made in step 11. Align the fin so it projects straight away from the body tube. Following the same procedure, attach the other two upper stage fins and the booster fins. Do not set either stage on its fins while the glue is wet.

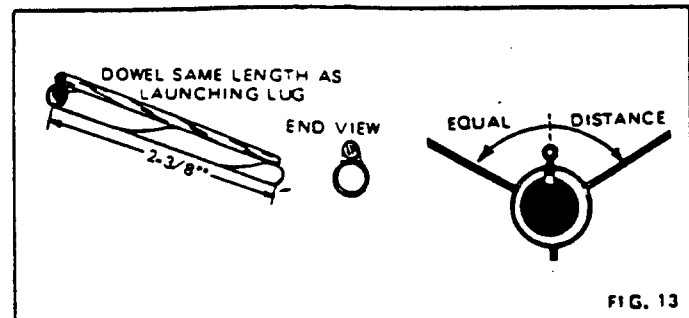

13. Cut the launch lug stand-off dowel to the same length as the launch lug. Apply a line of glue to one side of the lug and press the stand-off into place on the glue. Make sure the two pieces are perfectly parallel. After the glue has set a few minutes, apply glue to the other side of the stand-off and attach the unit to the upper stage mid-way between two fins so the rear of the lug is 1-1/4" ahead of the front of the fins. Be sure the unit runs parallel to the body tube.

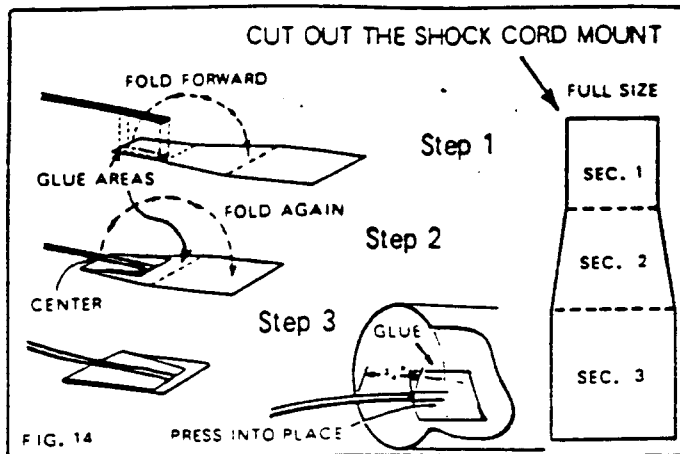

14. Cut out the shock cord mount and prefold it on the dotted lines. Lay the mount out flat, apply glue to section 1 and lay the shock cord into the glue. Fold this section over as shown in the illustration. Spread glue over the back of the first section and the exposed part of the second section. Lay the shock cord as shown and fold over again. Clamp the unit together with your fingers while the glue sets. Apply glue to the inside of the body tube over an area approximately 1" to 1-1/2" from the front end. The glue should cover a shape about the same as the shock cord mount. Press the mount onto the glue and hold it until the glue sets.

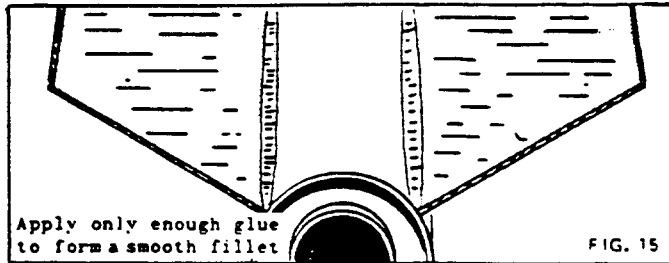

15. When the first glue on the fins has dried, apply a fillet of glue to each of the fin-body joints and to the launch lug support as shown. The fillets should be smooth and free of bubbles. Support the rocket horizontally while the glue dries.

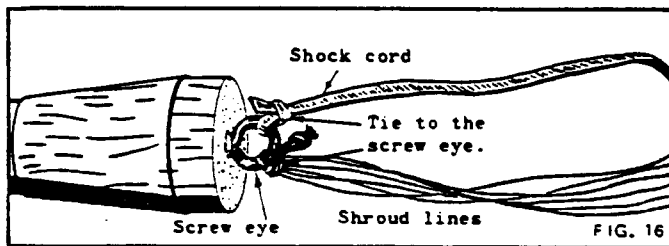

16. Install the nose cone on the front of the payload section. Connect the shock cord, parachute and screw eye as shown in fig. 16. Push the parachute into the body tube, packing the shroud lines and shock cord in over it. Push the base of the adapter into the forward end of the body tube.

17. Before finishing let all the glue on the outside of the rocket dry so it is hard and clear. Cover all balsa surfaces with a coat of sanding sealer. Let it dry completely and sand lightly with extra fine sandpaper. Apply a second coat, sand and apply still another coat until all the pores in the balsa are filled and the surfaces look and feel smooth. Give the rocket a clean base coat of glossy white paint or dope, let dry and follow with a high visibility color such as red, fluorescent orange, cerise, etc. to aid in tracking and retrieving.

## GENERAL INFORMATION

The maximum recommended payload weight for the Astron Avenger is 1 oz. when a Series I booster engine is used and 2 oz. when a Series II booster engine is used. The engines suggested for the first stage are the A4-0, B6-0, B14-0 and C6-0. For the upper stage A5-4, B6-6 and C6-7 engines are recommended. This model is designed for launching with either a rod or a "C" rail—in either case the guiding device should be at least 36" long. Follow the countdown procedure given below to eliminate mistakes and obtain top performance.

